

Contemporary
Lighting™

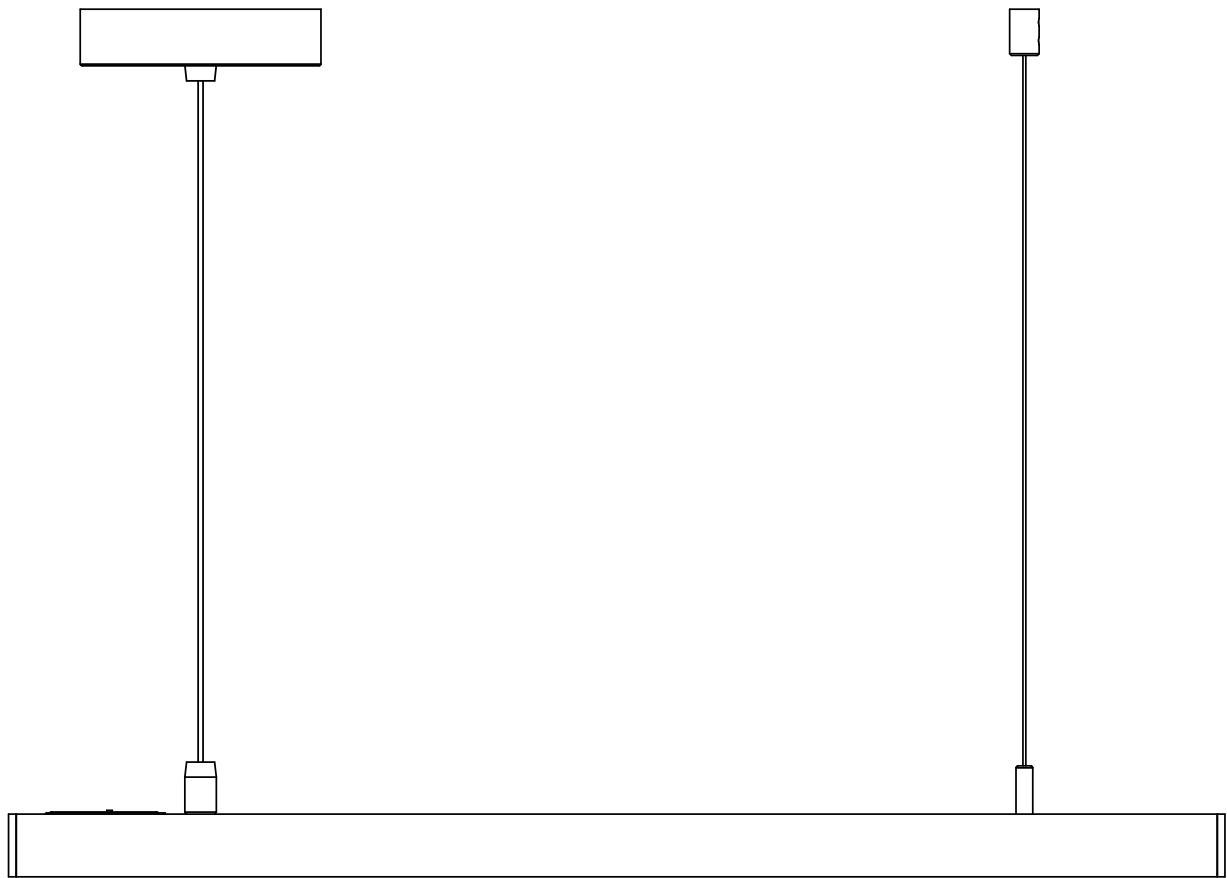





Item/Model Number: _____



Please consult a qualified electrician prior to install
Veuillez consulter un électricien qualifié pour suspendre le luminaire et le câblage.

Made in China | Fabrique en Chine | Hecho en China

LED LOW-VOLTAGE INSTRUCTIONS

| English Before Getting Started | Français Avant de Commencer | Español Antes de Comenzar |
|--|--|---|
| Read the instructions carefully prior to assembling the product. | Lire attentivement les instructions avant d'assembler le produit. | Lea atentamente las instrucciones antes de ensamblar el producto. |
| When you open the package with a sharp tool like a box knife, be careful not to damage the components inside. | Lorsque vous ouvrez le paquet avec un outil pointu comme un couteau de coupe, veillez à ne pas endommager les composants à l'intérieur. | Cuando abra el paquete con una herramienta afilada como un cuchillo de corte, tenga cuidado de no dañar los componentes dentro. |
| Carefully remove all packaging materials and retain for future use. | Retirez soigneusement tous les matériaux d'emballage et conservez-les pour un usage ultérieur. | Retire con cuidado todos los materiales de embalaje y consérvelos para usarlos en el futuro. |
| Keep all hardware parts and packaging out of reach of small children. | Conservez toutes les pièces matérielles et les emballages hors de portée des petits enfants. | Mantenga todas las piezas y embalajes de hardware fuera del alcance de los niños pequeños. |
| Choose a clean, level, spacious assembly area. Avoid hard surfaces that may damage the product. | Choisissez une zone d'assemblage propre, de niveau et spacieuse. Évitez les surfaces dures qui pourraient endommager le produit. | Elija una zona de ensamblaje limpia, nivelada y espaciosa. Evite superficies duras que puedan dañar el producto. |
| Ensure that you have all required contents for complete assembly. | Assurez-vous que vous avez tous les contenus requis pour l'assemblage complet. | Asegúrese de que tiene todos los contenidos necesarios para el ensamblaje completo. |
| Take care when lifting. Assemble the product in close proximity to where you intend to install it. | Prenez soin de soulever. Assemblez le produit à proximité de l'endroit où vous comptez positionner l'élément. | Tenga cuidado al levantar. Ensamble el producto cerca de donde tiene la intención de posicionar el artículo. |
| Do not over tighten the screws and bolts as this may damage the threads. | Ne serrez pas trop les vis et les boulons car cela pourrait endommager les filets. | No apriete excesivamente los tornillos y pernos, ya que esto puede dañar los hilos. |
| Do not let children play with this product. | Ne laissez pas les enfants jouer avec ce produit. | No permita que los niños jueguen con este producto. |
|  Risk of suffocation! Keep packaging materials away from children. |  Risque asphyxie! Tenez tous les matériaux emballage à l'écart des enfants |  Riesgo de sofocación! Mantenga los materiales de emb/alaje lejos de los niños. |
| Lamp Care Instructions | Entretien de la Lampe | Instrucciones de Lámparas |
| Carefully read through the instruction sheet before assembly and using the product. | Avant de procéder à l'assemblage et à l'utilisation de la lampe, lisez attentivement le mode d'emploi. | Lea cuidadosamente la hoja de instrucciones (si fue proporcionada) antes de armar y utilizar la lámpara. |
|  Caution there is a risk of shock! Disconnect from power source before assembling or cleaning. |  Pour éviter tout risque d'électrocution, débranchez la lampe de la prise électrique avant de procéder à l'assemblage ou au nettoyage de la lampe. |  Peligro por descarga eléctrica. Desconecte la lámpara de la fuente de electricidad antes de armarla o limpiarla. |
| Switch off, unplug and allow bulb to cool before replacing bulb or cleaning. | Avant de remplacer ou de nettoyer l'ampoule, éteignez et débranchez la lampe. | Apáguela, desenchúfela y deje que la bombilla se enfríe antes de reemplazarla o limpiarla. |
| Only use the recommended bulb type and do not exceed the maximum wattage as it could cause fire. | Afin d'éviter tout risque de feu, utilisez le type et la puissance d'ampoule recommandés. | Solo utilice el tipo de bombilla recomendado y no exceda la potencia eléctrica máxima ya que puede causar un incendio. |
| Check the product cord to be sure is free torn or frayed. | Ne branchez pas la lampe si son cordon d'alimentation est déchiré ou effiloché | No conecte la lámpara si el cable eléctrico está dañado o deshilachado. |
|  WARNING: Wires must be connected to low voltage driver and should not be connected directly to live wire or a short may occur. |  AVERTISSEMENT : Les fils doivent être connectés au conducteur et ne doivent pas être connectés directement aux fils sous tension |  ADVERTENCIA: Los cables deben estar conectados al controlador y no deben conectarse directamente al cable activo |
| Cleaning & Maintenance | Nettoyage et Maintenance | Limpieza y Mantenimiento |
| On polished finishes, often using talc powder can reduce the appearance of fingerprints and other smudges. | Sur les finitions polies, souvent en utilisant la poudre de talc réduit l'apparence des empreintes digitales et d'autres taches. | En acabados pulidos, a menudo usando polvo de talco reduce la aparición de huellas dactilares y otras manchas. |
| For respective shade surfaces, use the appropriate cleansers, i.e. glass cleaner, stone polish, & wood polish. | Pour les surfaces d'ombrage respectives, utilisez les nettoyants appropriés, c'est-à-dire le nettoyant pour vitres, vernis à pierre et le vernis à bois. | Para las respectivas superficies de sombra, utilice los limpiadores apropiados, es decir, limpiador de vidrio, esmalte acrílico y pulido de madera. |
| Clean with soft cloth and a mild detergent. Do not use abrasive or harsh cleaners. | Nettoyer avec un chiffon doux et un détergent doux. N'utilisez pas de nettoyant abrasif. | Utilice un trapo limpio, suave y seco que no raye ni manche la superficie cuando quite el polvo. |
| Periodically (every 90-180 days) make sure that the screws are fully tightened. | Périodiquement (tous les 90-180 jours), assurez-vous que les vis sont bien serrées. | Periódicamente (cada 90-180 días) asegúrese de que los tornillos estén bien apretados. |
| Prolonged exposure to heat sources may cause glazing, melting and scorching, or even cause color to fade. | Si le tissu subit une exposition prolongée aux sources de chaleur, il pourrait commencer à reluire, à roussir, à s'estomper ou même à se décolorer. | La exposición prolongada a las fuentes de calor causa cristalización, derretimiento, quemadura y decoloración del tapizado. |

English

PARTS

Before getting started, ensure the package contains the following components:

Français



PIÈCES

Antes de comenzar, asegúrese de que el paquete contenga los siguientes componentes:

Espanol

PASRTES

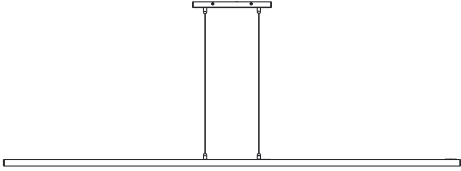
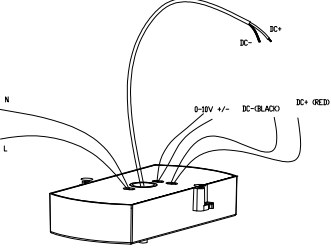
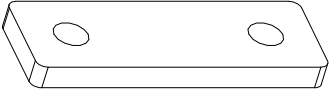
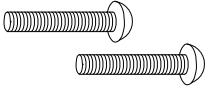
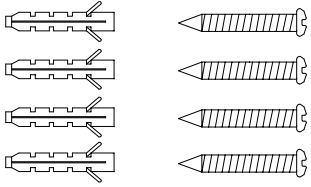
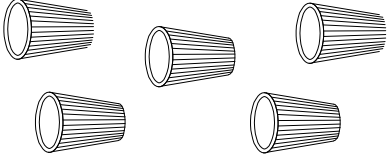
Avant de commencer, assurez-vous qu le paquet contient les composants suivants:

| | | | | | |
|------------|---|-----------|------------|---|-----------|
| <p>(A)</p> |  | <p>x1</p> | <p>(H)</p> |  <p>DV1045</p> | <p>x2</p> |
| <p>(B)</p> |  | <p>x1</p> | | | |
| <p>(C)</p> |  <p>#8-32x1</p> | <p>x2</p> | | | |
| <p>(D)</p> |  <p>PL0630 PA4*20mm</p> | <p>x4</p> | | | |
| <p>(E)</p> |  | <p>x5</p> | | | |
| <p>(F)</p> |  | <p>x1</p> | | | |
| <p>(G)</p> |  <p>Lifting Rope</p> | <p>x2</p> | | | |

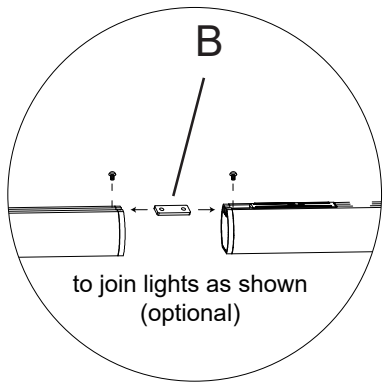
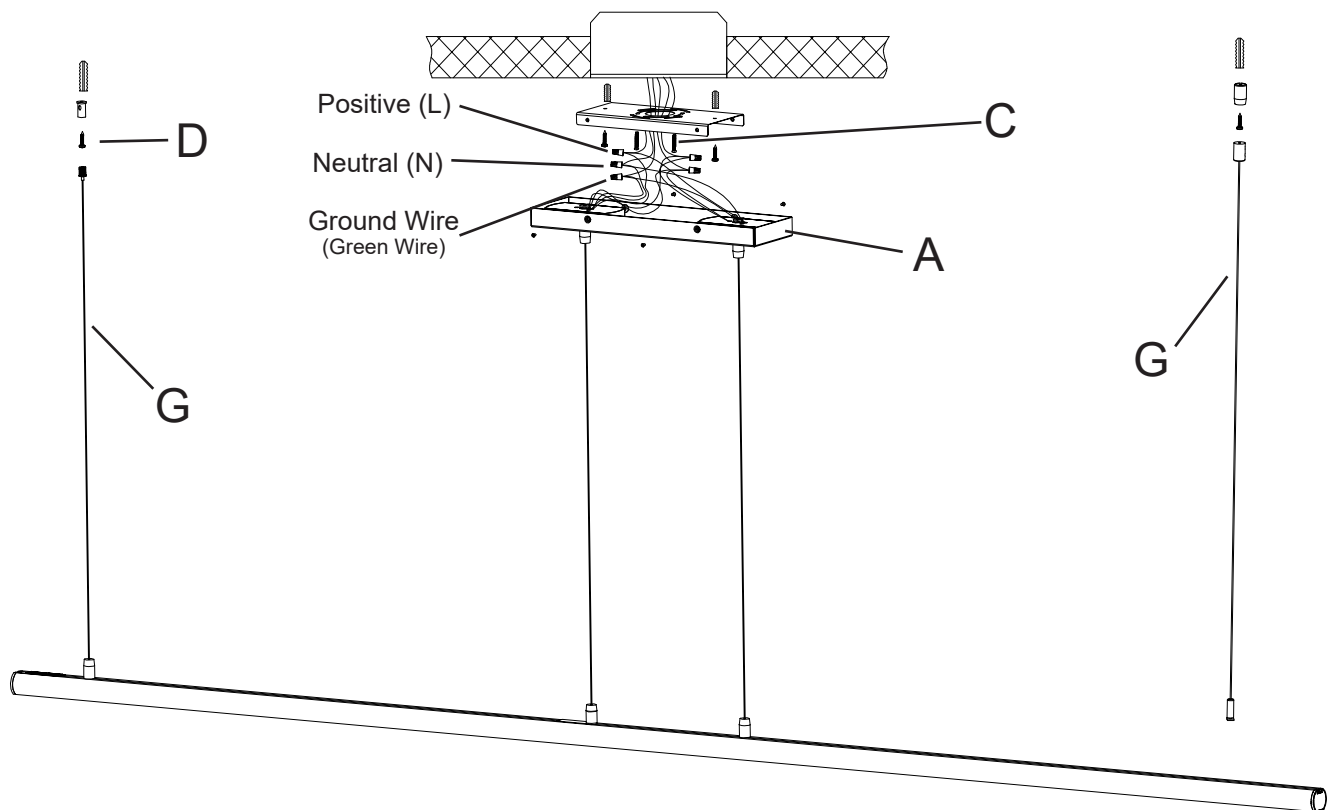

- 1: Connect the wires with wire nuts. Connect white to white, black to black and green wire to green wire as grounding connection. Also connect the dimming wire.
- 2: Fix the mounting plate on the junction box , adjust the wire to suitable length
- 3: Install the base with fixing nut on the driver
- 4: Install the fixing nut on the ceiling
- 5: Tighten the lifting rope to the fixing nut
- 6: Attach the lifting rope to the slot behind the fixture and tighten the nut , adjust the rope to suitable length



ITEM/MODEL: E26008

MUST be installed by an experienced professional
CRITICAL KNOWLEDGE of electronic lighting systems required

IMPROPER WIRING and/or INCORRECT DIMMER use can cause CATASTROPHIC DAMAGE!

THIS FIXTURE MUST BE INSTALLED with a COMPATIBLE DIMMER SWITCH

DO **NOT** CUT FACTORY-MADE CONNECTIONS.

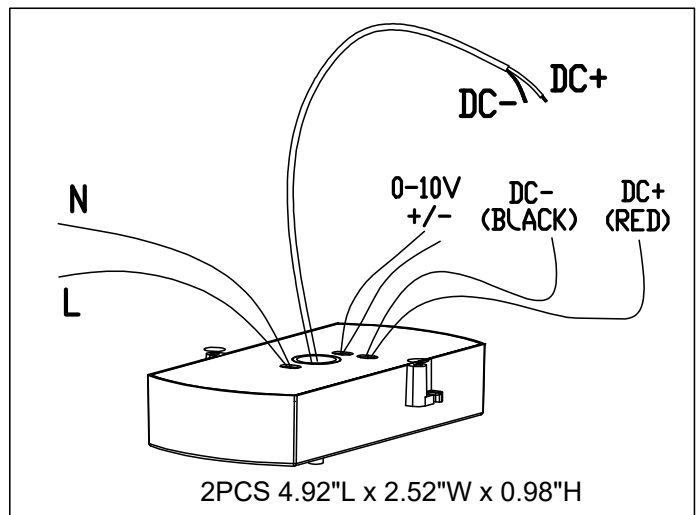
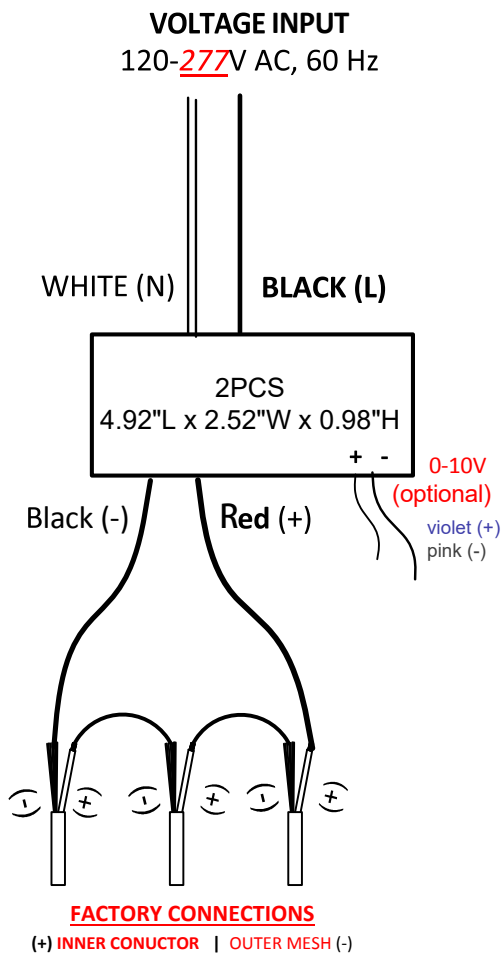

SCHEMATIC FOR GENERAL REFERENCE ONLY

VERIFIED LIST OF TESTED DIMMERS

- Lutron DVCL-153P
- Lutron SCL-153P
- Leviton IPLO6
- Leviton 6674
- Deako Simple Dimmer

Due to inrush current, wattage should not exceed 150W on a 600W dimmer

GENERAL COMPATIBILITY

TRIAC / FORWARD PHASE ELV / REVERSE PHASE: ONLY WORK AT 120VAC

0-10V / LOW VOLTAGE: WORK AT 120-277VAC

IMPORTANT!

If the control is not paired properly to LED fixtures, irreparable damage may occur.

If the dimmer you are using is not listed here, consult a lighting professional or view our Dimming Compatibility Chart online: www.et2online.com