

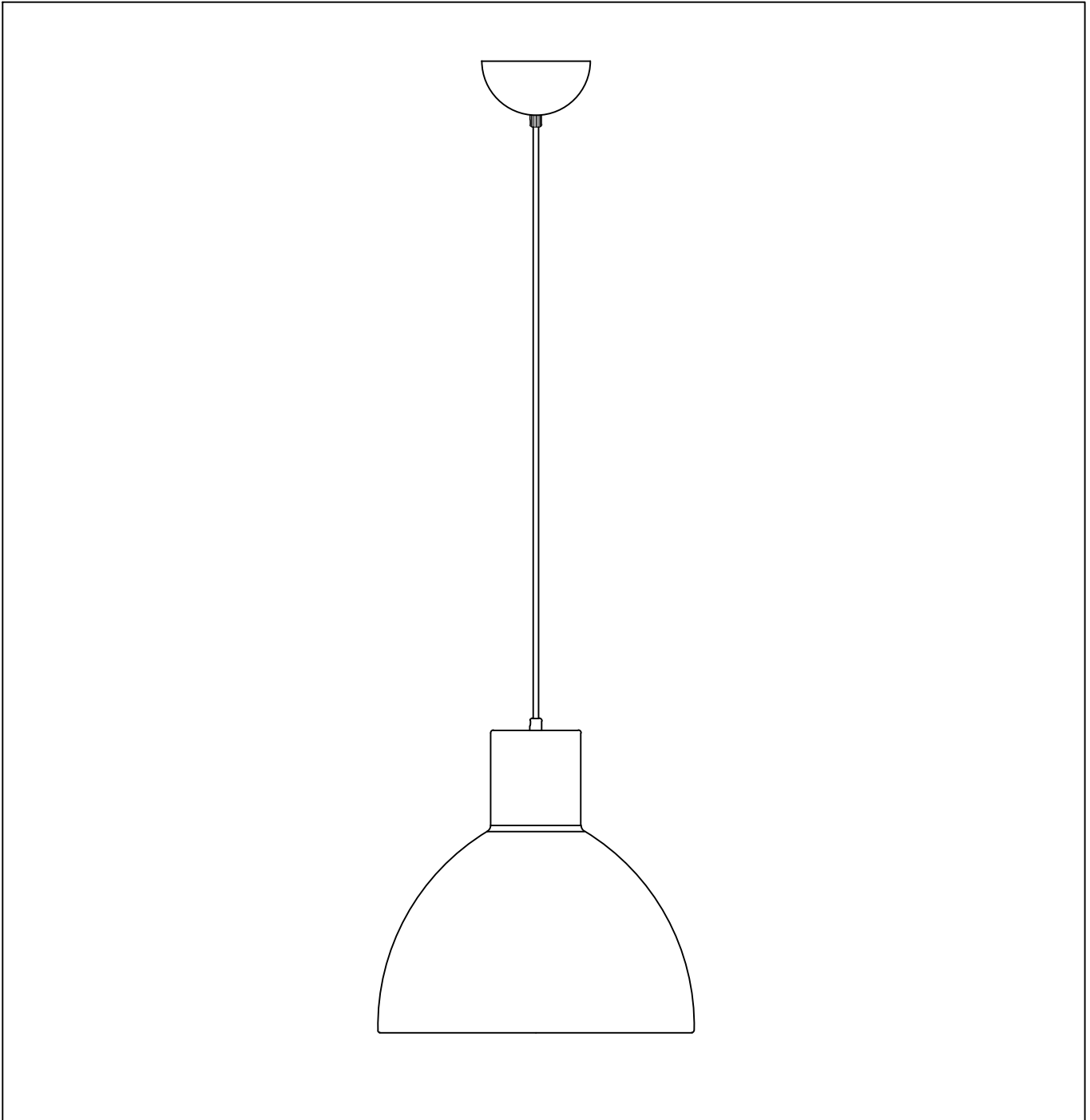

PRODUCT NAME: Cora 1LT Pendant
ITEM NUMBER: 11024

Please consult your electrician for hanging fixture and wiring.



Bulbs (Not included):1*E26*60W

IMPORTANT: Turn off the power at the main fuse or circuit breaker box before starting installation

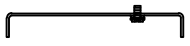

Bracket (A)



Screws(B)



Canopy(C)



Mounting Screws(D)



Plastic
Screws(E)

Locate all hardware & components before discarding packaging

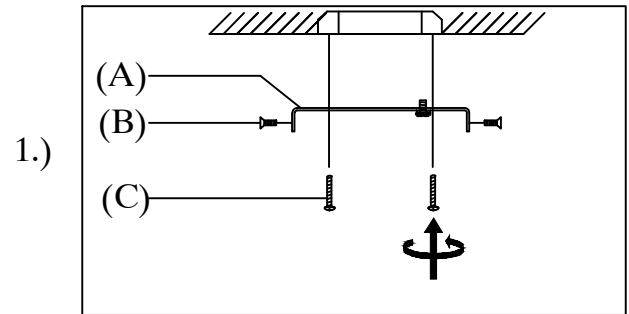
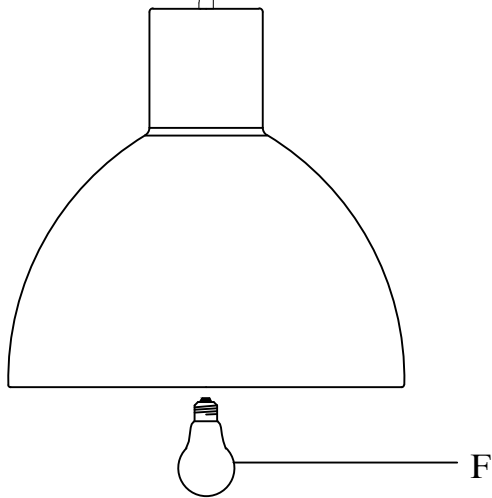
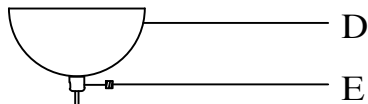
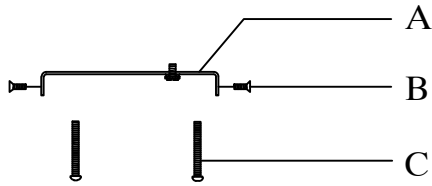

Step1 :Remove mounting bracket from fixture and install to electrical box.

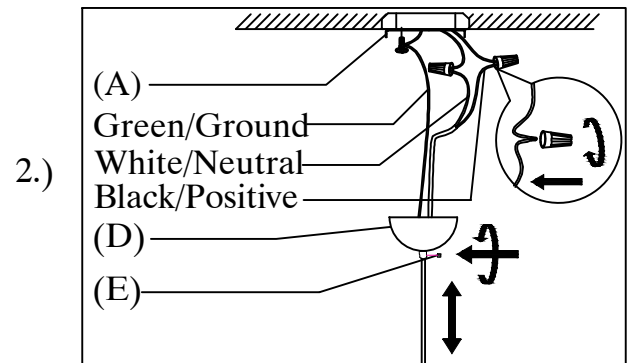

Step2 :Adjust wire length to desired mounting height, and tighten strain relief screws to secure. Wire fixture to wires in outlet box. Green wire is for Ground.

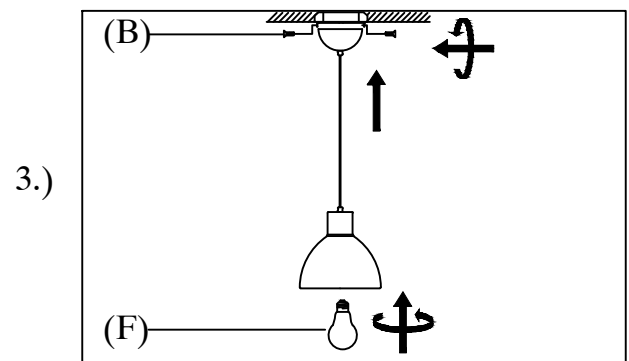

Step3 :Install fixture to bracket and tighten screws at the ends of the canopy to secure. Install bulb into socket.

Cleaning & Care:
Clean with soft cloth and a mild detergent.
Do not use abrasive cleaner.