

NIO-4SNDC

4" Iolite Square Reflector with Round Aperture

Source: 14W to 28W LED
800lm to 2500lm

Type

Project

Catalog No.

Notes

PRODUCT DESCRIPTION

4" Iolite reflectors can be specified for use with Iolite new construction or remodel housings. Deep regressed cone reflectors optimize visual cut-off.

FEATURES

- 800lm, 1000lm, 1500lm, 2000lm or 2500lm LED packages
- 2700K, 3000K, 3500K, 4000K, 5000K @ 90+ CRI
- Cree® LED COB or Comfort Dim Technology
- Flood optic, narrow flood and spot optics (included)
- 5-Year limited warranty

SPECIFICATION

Construction: Reflectors are constructed of heat dissipating, die-cast aluminum. The aluminum die-cast LED heat sink is threaded to fit the reflector and transfer heat.

Mounting: Reflector includes friction blades to mount securely to housing.

OPTICS

800-1000lm: Each reflector includes field changeable optics (flood, narrow flood and spot). Premium 15° and 25° TIR optics are also available.

1500-2500lm: Each reflector includes field changeable TIR optics (flood, narrow flood and spot).

ELECTRICAL

Lumens / Wattage: 800lm / 14W, 1000lm / 14W, 1500lm / 20W, 2000lm / 24W, 2500lm / 28W

Color Temperature: 2700K, 3000K, 3500K, 4000K, 5000K

CRI: 90+ CRI

Operating Temp.: Specified by housing

Lifetime: 50,000 hours @ L70

Comfort Dim: Comfort Dim color tunes the temperature from a bright 3100K, to a romantic and comfortable 2000K on a gradual, even curve. Available in 800lm only.

Dimming: Specified by housing

COMPATIBLE HOUSINGS

Reflectors are compatible with respective Iolite housings manufactured by Nora Lighting.

CATALOG NO.	DESCRIPTION	LUMENS / WATTAGE
NHIOICD-48	ICAT New Construction	800-1000lm / 14W
NHIOICDCP-48	Chicago Plenum	800-1000lm / 14W
NHRIOIC-48	ICAT Remodel	800-1000lm / 14W
NHIOICD-415	ICAT New Construction	1500lm / 20W
NHIOICDCP-415	Chicago Plenum	1500lm / 20W
NHIOICD-420	ICAT New Construction	2000lm / 24W
NHIOICDCP-420	Chicago Plenum	2000lm / 24W
NHIOICD-425	ICAT New Construction	2500lm / 28W
NHIOICDCP-425	Chicago Plenum	2500lm / 28W

Accessories: Reflectors will accommodate (1) hex louver and (1) translucent deco collar or opaque snoot, no accessory holder is required, see accessories page. Flush mount mud ring is available to give the appearance of a trimless reflector, compatible with new construction housing only.

LABELS AND LISTINGS

- cULus Listed for Wet Locations
- ENERGY STAR certified
- [5-Year Limited Warranty](#)
- RoHS Compliant
- Can be used to comply with 2019 Title 24 - part 6 High Efficacy LED light source requirements



PRODUCT IMAGES & DIMENSIONS

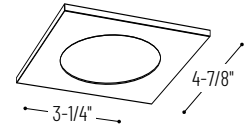

NIO-4SNDC
Square Reflector with Round Aperture
Non-Adjustable

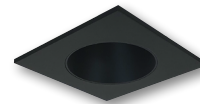

BB
Black Reflector
Black Flange

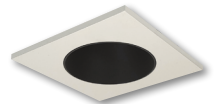

BW
Black Reflector
White Flange

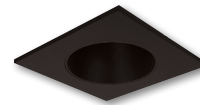

BZ
Bronze Reflector
Bronze Flange

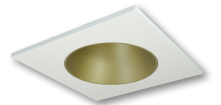

CHMPW
Champagne Haze Reflector
Matte Powder White Flange



HW
Haze Reflector
White Flange



HZMPW
Haze Reflector
Matte Powder White Flange



MPW
Matte Powder White Reflector
Matte Powder White Flange

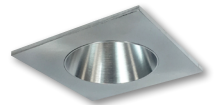

NN
Natural Metal Reflector
Natural Metal Flange



WW
White Reflector
White Flange

4" Iolite Square Reflector with Round Aperture - Dedicated Housing Required

Reflector Type	Color Temp.	Finish	Lumens / Wattage
NIO-4SNDC = Square Reflector with Round Aperture	27X = 2700K	BB = Black / Black	(blank) = 800lm / 14W
	30X = 3000K	BW = Black / White	/10 = 1000lm / 14W
	35X = 3500K	BZ = Bronze / Bronze	/HL = 1500-2500lm
	40X = 4000K	CHMPW = Champagne / Matte Powder White	(varies by housing)
	50X = 5000K	HW = Haze / White	
	CDX = Comfort Dim [†]	HZMPW = Haze / Matte Powder White	
			MPW = Matte Powder White
		NN = Natural Metal / Natural Metal	
		WW = White / White	

Compatible Housings

Housing Type
NHIOICD-48 = ICAT New Construction / 800-1000lm / 14W
NHIOICDCP-48 = Chicago Plenum / 800-1000lm / 14W
NHRIOIC-48 = ICAT Remodel / 800-1000lm / 14W
NHIOICD-415 = ICAT New Construction / 1500lm / 20W
NHIOICDCP-415 = Chicago Plenum / 1500lm / 20W
NHIOICD-420 = ICAT New Construction / 2000lm / 24W
NHIOICDCP-420 = Chicago Plenum / 2000lm / 24W
NHIOICD-425 = ICAT New Construction / 2500lm / 28W
NHIOICDCP-425 = Chicago Plenum / 2500lm / 28W

[†] Comfort Dim technology available in 800lm & uses non-Cree COB modules. 1" & 2" Iolite uses a different dimming curve than 4" Comfort Dim

Example: **NIO-4SNDC27XWW** = 4" Iolite Square Reflector with Round Aperture, 2700K, White finish, 800lm / 14W

4" Iolite Accessories

4" Iolite Square Reflector with Round Aperture

Type
Project
Catalog No.
Notes

FIELD CHANGEABLE OPTICS

Iolite reflectors include spot, narrow flood and flood optics. Optics can be changed in the field by removing LED module from die-cast reflector. Replacement optics include an optional frosted lens.

Note: Frosted filter-optics and Premium TIR optics are not compatible with /HL LED modules.

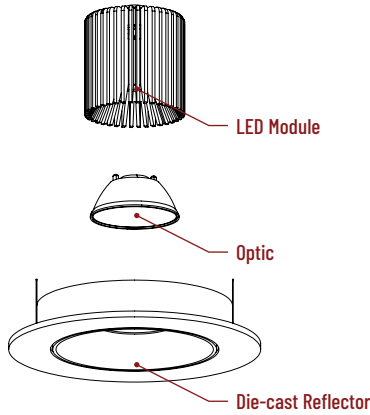

Frosted Filter-Optic

NIO-REFL15FR	15° Optic
NIO-REFL25FR	25° Optic
NIO-REFL38FR	38° Optic
NIO-REFL60FR	60° Optic

Optic assembly includes optional frosted lens. 25°, 38° and 60° optics are included with 800lm and 1000lm reflector.
Not compatible with /HL LED module.



Premium TIR Optics

NIO-REFLTIR15	15° Optic
NIO-REFLTIR25	25° Optic

Not compatible with /HL LED module or Comfort Dim (CDX) technology

ACCESSORIES

Iolite accessories can be added at any point in the design process. Accessories easily install between LED module and die-cast reflector. Luminaire will accommodate (1) hex louver and (1) collar accessory, no accessory holder required.

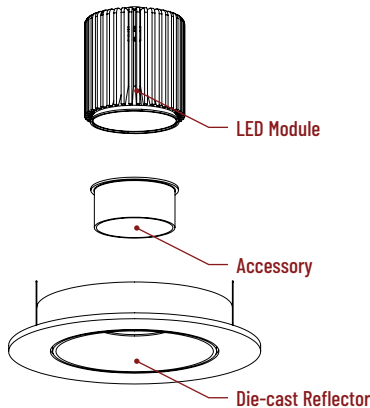

Translucent Decorative Collar

NIO-AS14(color)	5/8" length
NIO-AS19(color)	3/4" length
NIO-AS26(color)	1" length
Color:	
AM (amber), BLU (blue), FR (frosted), R (red)	

Translucent collars color the aperture with the specified color while producing white general light. Collars are available in different lengths. Use to add interest, create a theme, match a theme or define a space.



Opaque Collar Snoot

NIO-AS14(color)	5/8" length
NIO-AS19(color)	3/4" length
NIO-AS26(color)	1" length
Color:	
BLK (black), MPW (matte powder white), WH (white)	

Opaque snoot greatly reduces aperture brightness while preserving light output. (Note: Black snoot will reduce light)



Hex Cell Louver

NIO-HC	Black
--------	-------

Hex cell louver subtly reduces aperture brightness by reducing light output by about 20%.

FLUSH MOUNT

4" Iolite reflectors can be installed flush with the drywall for a flush mount appearance. A flush mount mud ring is installed after the drywall and a professional drywall finisher floats the ceiling to blend in the mud ring.

Flush Mount Mud Ring

NIO-FMMR-4S	Square Mud Ring
-------------	-----------------

Mounts reflector flush to ceiling with flange visible. Mud ring attaches to drywall. **Only for use with NH10ICD-48 or NH10ICDCP-48 new construction housings and NIO-4S reflectors.** Dimensions: 7-7/8" diameter 1/2" thick

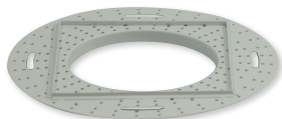

PHOTOMETRICS

4" Iolite Square Reflector with Round Aperture
800 lumens

Type

Project

Catalog No.

Notes

Test Information

Test Number: NTR11291
Part Number: NIO-4SNDC30XBW
Beam Spread: 27° Spot
Lumens: 880lm
Wattage: 14.64W
Efficacy: 60lpw
CCT / CRI: 3000K / 90 CRI
Spacing Criteria (0°-180): 0.46
Spacing Criteria (90°-270): 0.16

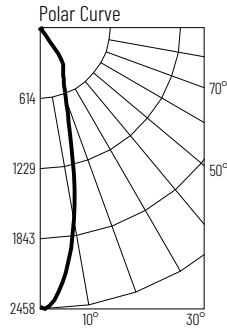

Illuminance at a Distance

Distance from Luminaire	FC at Nadir	Beam Diameter
4'	153fc	1'-11"
6'	67.8fc	2'-11"
8'	38.2fc	3'-11"
10'	24.4fc	4'-11"
12'	17fc	5'-10"

Zonal Lumen Summary

Zone	Lumens	% Luminaire
0-30	715	81.2
0-40	858	97.5
0-60	877	99.6
0-90	877	99.6
90-180	3	0.4
0-180	880	100

Candela Table

Vertical Angles	Candela
0	2442
5	2220
15	1050
25	480
35	265
45	20

Test Information

Test Number: NTR11299
Part Number: NIO-4SNDC30XBW
Beam Spread: 40° Narrow Flood
Lumens: 850lm
Wattage: 14.73W
Efficacy: 58lpw
CCT / CRI: 3000K / 90 CRI
Spacing Criteria (0°-180): 0.66
Spacing Criteria (90°-270): 0.66

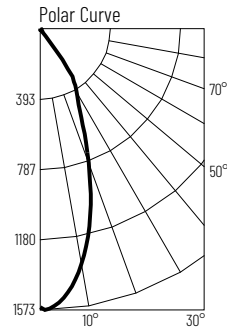

Illuminance at a Distance

Distance from Luminaire	FC at Nadir	Beam Diameter
4'	97.4fc	2'-11"
6'	43.3fc	4'-5"
8'	24.3fc	5'-11"
10'	15.6fc	7'-4"
12'	10.8fc	8'-10"

Zonal Lumen Summary

Zone	Lumens	% Luminaire
0-30	687	80.8
0-40	831	97.8
0-60	847	99.6
0-90	847	99.7
90-180	3	0.3
0-180	850	100

Candela Table

Vertical Angles	Candela
0	1558
5	1484
15	1067
25	540
35	263
45	15

Test Information

Test Number: NTR11231
Part Number: NIO-4SNDC30XBW
Beam Spread: 60° Flood
Lumens: 841lm
Wattage: 14.75W
Efficacy: 57lpw
CCT / CRI: 3000K / 90 CRI
Spacing Criteria (0°-180): 0.88
Spacing Criteria (90°-270): 0.88

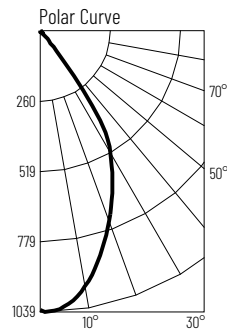

Illuminance at a Distance

Distance from Luminaire	FC at Nadir	Beam Diameter
4'	64.5fc	4'-7"
6'	28.7fc	6'-10"
8'	16.1fc	9'-1"
10'	10.3fc	11'-5"
12'	7.2fc	13'-8"

Zonal Lumen Summary

Zone	Lumens	% Luminaire
0-30	622	73.9
0-40	812	96.6
0-60	837	99.6
0-90	838	99.7
90-180	3	0.3
0-180	841	100

Candela Table

Vertical Angles	Candela
0	1032
5	1017
15	855
25	625
35	327
45	26

PHOTOMETRICS

4" Iolite Square Reflector with Round Aperture
1000 lumens

Type

Project

Catalog No.

Notes

Test Information

Test Number: NTR11291
Part Number: NIO-4SNDC30XBW/10
Beam Spread: 27° Spot
Lumens: 1089lm
Wattage: 13.53W
Efficacy: 81lpw
CCT / CRI: 3000K / 90 CRI
Spacing Criteria (0°-180): 0.46
Spacing Criteria (90°-270): 0.48

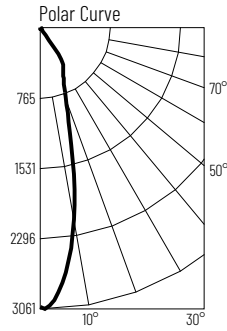

Illuminance at a Distance

Distance from Luminaire	FC at Nadir	Beam Diameter
4'	189fc	1'-11"
6'	84.1fc	2'-11"
8'	47.3fc	3'-11"
10'	30.3fc	4'-10"
12'	21fc	5'-10"

Zonal Lumen Summary

Zone	Lumens	% Luminaire
0-30	884	81.1
0-40	1062	97.5
0-60	1085	99.6
0-90	1085	99.6
90-180	4	0.4
0-180	1089	100

Candela Table

Vertical Angles	Candela
0	3027
5	2721
15	1292
25	586
35	329
45	24

Test Information

Test Number: NTR11230
Part Number: NIO-4SNDC30XBW/10
Beam Spread: 41° Narrow Flood
Lumens: 1059lm
Wattage: 13.42W
Efficacy: 79lpw
CCT / CRI: 3000K / 90 CRI
Spacing Criteria (0°-180): 0.66
Spacing Criteria (90°-270): 0.66

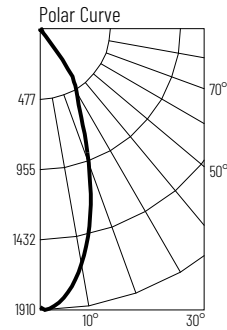

Illuminance at a Distance

Distance from Luminaire	FC at Nadir	Beam Diameter
4'	118fc	3'
6'	52.6fc	4'-6"
8'	29.6fc	5'-11"
10'	18.9fc	7'-5"
12'	13.1fc	8'-11"

Zonal Lumen Summary

Zone	Lumens	% Luminaire
0-30	851	80.4
0-40	1028	97
0-60	1055	99.6
0-90	1055	99.7
90-180	4	0.3
0-180	1059	100

Candela Table

Vertical Angles	Candela
0	1893
5	1805
15	1305
25	681
35	279
45	19

Test Information

Test Number: NTR11232
Part Number: NIO-4SNDC30XBW/10
Beam Spread: 60° Flood
Lumens: 1042lm
Wattage: 13.5W
Efficacy: 77lpw
CCT / CRI: 3000K / 90 CRI
Spacing Criteria (0°-180): 0.9
Spacing Criteria (90°-270): 0.88

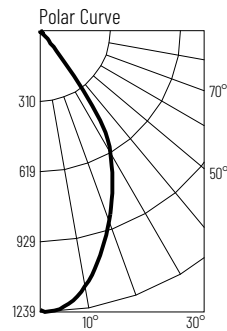

Illuminance at a Distance

Distance from Luminaire	FC at Nadir	Beam Diameter
4'	76.6fc	4'-6"
6'	34fc	6'-8"
8'	19.1fc	9'
10'	12.2fc	11'-2"
12'	8.5fc	13'-6"

Zonal Lumen Summary

Zone	Lumens	% Luminaire
0-30	744	71.4
0-40	979	94
0-60	1037	99.6
0-90	1038	99.7
90-180	4	0.3
0-180	1042	100

Candela Table

Vertical Angles	Candela
0	1225
5	1194
15	1024
25	767
35	367
45	57