

NIOB-ISNG

1" Iolite BWF Square Reflector with Round Aperture

Source: 9W or 10W LED
600lm

Type

Project

Catalog No.

Notes

PRODUCT DESCRIPTION

1" Iolite BWF reflectors can be specified for use with Iolite new construction or remodel housings. Straight reflector with sharp edge optimizes visual cut-off.

FEATURES

- 600lm / 9W or 10W
- 2700K, 3000K, 3500K, 4000K, 5000K @ 90+ CRI
- Cree® LED COB or Comfort Dim Technology
- 60° (Flood) optic installed, 40° (Narrow flood) and 20° (Spot) optics included
- 5-Year limited warranty

SPECIFICATION

Construction: Reflectors are constructed of heat dissipating, die-cast aluminum. The aluminum die-cast LED heat sink is threaded to fit the reflector and transfer heat.

Mounting: Reflector includes friction blades to mount securely to housing.

Field Changeable Optics: Each reflector comes with a 60° (installed), 40° and 20° optics (included).

ELECTRICAL

Lumens / Wattage: 600lm / wattage varies by housing (9W / LE3 or 10W / LE4)

Color Temperature: 2700K, 3000K, 3500K, 4000K, 5000K

CRI: 90+CRI

Operating Temp.: 0°C to 40°C ambient temperature

Lifetime: 50,000 hours @ L70

Comfort Dim: Comfort Dim color tunes the temperature from a bright 3100K, to a romantic and comfortable 2000K on a gradual, even curve.

Dimming: Specified by housing

COMPATIBLE HOUSINGS

Reflectors are compatible with respective Iolite housings manufactured by Nora Lighting.

CATALOG NO.	DESCRIPTION	LUMENS / WATTAGE
NHIOICD-16LE3	ICAT New Construction, 120V; Triac/ELV	600lm / 9W
NHIOICD-16LE4	ICAT New Construction, 120-277V; Triac/ELV/0-10V	600lm / 10W
NHIOICDCP-16LE3	Chicago Plenum, 120V; Triac/ELV	600lm / 9W
NHIOICDCP-16LE4	Chicago Plenum, 120-277V; Triac/ELV/0-10V	600lm / 10W
NHRIOIC-16LE4	ICAT Remodel, 120-277V; Triac/ELV/0-10V	600lm / 10W

Accessories: Reflectors will accommodate (1) hex louver and (1) translucent deco collar or opaque snoot, no accessory holder is required, see accessories page.

LABELS AND LISTINGS

- cULus Listed for Wet Locations
- ENERGY STAR certified
- [5-Year Limited Warranty](#)
- RoHS Compliant
- Can be used to comply with 2019 Title 24 - part 6 High Efficacy LED light source requirements



PRODUCT IMAGES & DIMENSIONS

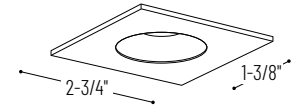

NIOB-ISNG

Square Reflector with Round Aperture
Non-Adjustable

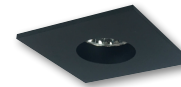

BB
Black Reflector
Black Flange

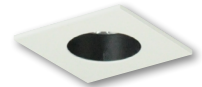

BW
Black Reflector
White Flange

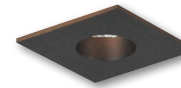

BZ
Bronze Reflector
Bronze Flange

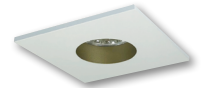

CHMPW
Black Reflector
Matte Powder White Flange

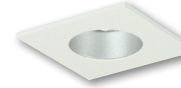

HW
Haze Reflector
White Flange



MPW
Matte Powder White Reflector
Matte Powder White Flange

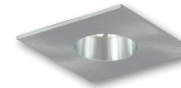

NN
Natural Metal Reflector
Natural Metal Flange



WW
White Reflector
White Flange

1" Iolite BWF Square Reflector with Round Aperture - Dedicated Housing Required

Reflector Type	Color Temp.	Finish
NIOB-ISNG = Square Reflector with Round Aperture	27X = 2700K	BB = Black / Black
	30X = 3000K	BW = Black / White
	35X = 3500K	BZ = Bronze / Bronze
	40X = 4000K	CHMPW = Champagne / Matte Powder White
	50X = 5000K	HW = Haze / White
	CDX = Comfort Dim [†]	MPW = Matte Powder White
		NN = Natural Metal / Natural Metal
	WW = White / White	

[†] Comfort Dim technology uses non-Cree COB modules. 1" & 2" Iolite uses a different dimming curve than 4" Comfort Dim

Compatible Housings

Housing Type
NHIOICD-16LE3 = ICAT New Construction / Triac/ELV / 600lm / 9W
NHIOICD-16LE4 = ICAT New Const. / Triac/ELV/0-10V / 600lm / 10W
NHIOICDCP-16LE3 = Chicago Plenum / Triac/ELV / 600lm / 9W
NHIOICDCP-16LE4 = Chicago Plenum / Triac/ELV/0-10V / 600lm / 10W
NHRIOIC-16LE4 = ICAT Remodel / Triac/ELV/0-10V / 600lm / 10W

Example: **NIOB-ISNG27XWW** = 1" Iolite BWF Square Reflector with Round Aperture, 2700K, White finish, 600lm

1" Iolite Accessories

1" Iolite BWF Square Reflector with Round Aperture

Type	
Project	
Catalog No.	
Notes	

FIELD CHANGEABLE OPTICS

Iolite reflectors include 20°, 40° and 60° optics. Optics can be changed in the field by removing LED module from die-cast reflector. Replacement optics include an optional frosted lens.

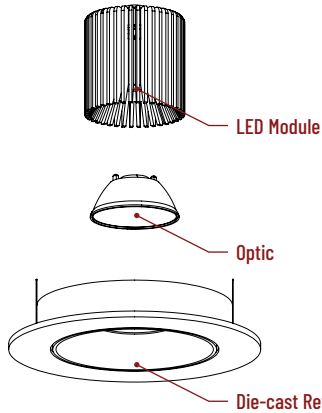

ACCESSORIES

Iolite accessories can be added at any point in the design process. Accessories easily install between LED module and die-cast reflector. Luminaire will accommodate (1) hex louver and (1) collar accessory, no accessory holder required.

Translucent Decorative Collar

NIO-1AS15(color)	5/8" length
NIO-1AS19(color)	3/4" length
NIO-1AS24(color)	1" length

Color:
AM (amber), BLU (blue), FR (frosted), R (red)

Translucent collars color the aperture with the specified color while producing white general light. Collars are available in different lengths. Use to add interest, create a theme, match a theme or define a space.

Opaque Collar Snoot

NIO-1AS15(color)	5/8" length
NIO-1AS19(color)	3/4" length
NIO-1AS24(color)	1" length

Color:
BLK (black), MPW (matte powder white), WH (white)

Opaque snoot greatly reduces aperture brightness while preserving light output. (Note: Black snoot will reduce light)

Hex Cell Louver

NIO-1HC Black

Hex cell louver subtly reduces aperture brightness by reducing light output by about 20%.

FLUSH MOUNT

1" Iolite BWF reflectors can be installed flush with the drywall for a flush mount appearance. A flush mount mud ring is installed after the drywall and a professional drywall finisher floats the ceiling to blend in the mud ring.

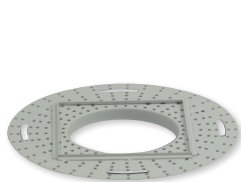

Flush Mount Mud Ring

NIO-FMMR-1S Square Mud Ring

Mounts trim flush to ceiling with reflector flange visible. **Mud ring attaches to drywall. Requires and only for use with NHIOICD-16 or NHIOICDCP-16 new construction housings and NIOB-1S reflectors.**

Dimensions: 7-7/8" diameter 1/2" thick

PHOTOMETRICS

1" Iolite BWF Square Reflector with Round Aperture
600 lumens

Type

Project

Catalog No.

Notes

Test Information

Test Number: NTR11212
Part Number: NIOB-ISNG27MPW
Beam Spread: 24° Spot
Lumens: 556lm
Wattage: 9.33W
Efficacy: 60lpw
CCT / CRI: 2700K / 90 CRI
Spacing Criteria (0°-180): 0.42
Spacing Criteria (90°-270): 0.42

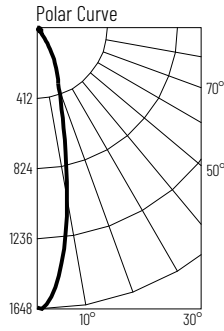

Illuminance at a Distance

Distance from Luminaire	FC at Nadir	Beam Diameter
4'	102fc	1'-8"
6'	45.6fc	2'-7"
8'	25.8fc	3'-6"
10'	16.4fc	4'-5"
12'	11.4fc	5'-2"

Zonal Lumen Summary

Zone	Lumens	% Luminaire
0-30	417	75
0-40	468	84.2
0-60	518	93.2
0-90	555	99.8
90-180	1	0.2
0-180	556	100

Candela Table

Vertical Angles	Candela
0	1640
5	1439
15	621
25	260
35	76
45	35

Test Information

Test Number: NTR11227
Part Number: NIOB-ISNG27MPW
Beam Spread: 38° Narrow Flood
Lumens: 551lm
Wattage: 9.4W
Efficacy: 59lpw
CCT / CRI: 2700K / 90 CRI
Spacing Criteria (0°-180): 0.64
Spacing Criteria (90°-270): 0.64

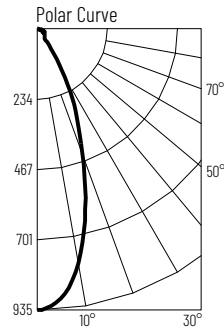

Illuminance at a Distance

Distance from Luminaire	FC at Nadir	Beam Diameter
4'	58.4fc	2'-10"
6'	26fc	4'-2"
8'	14.6fc	5'-7"
10'	9.4fc	7'
12'	6.5fc	8'-6"

Zonal Lumen Summary

Zone	Lumens	% Luminaire
0-30	392	71.2
0-40	449	81.4
0-60	506	91.7
0-90	550	99.8
90-180	1	0.2
0-180	551	100

Candela Table

Vertical Angles	Candela
0	934
5	898
15	627
25	306
35	83
45	36

Test Information

Test Number: NTR11243
Part Number: NIOB-ISNG27MPW
Beam Spread: 54° Flood
Lumens: 545lm
Wattage: 9.33W
Efficacy: 58lpw
CCT / CRI: 2700K / 90 CRI
Spacing Criteria (0°-180): 0.84
Spacing Criteria (90°-270): 0.84

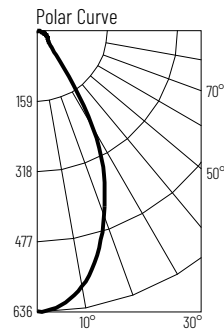

Illuminance at a Distance

Distance from Luminaire	FC at Nadir	Beam Diameter
4'	39.6fc	4'-1"
6'	17.6fc	6'-1"
8'	9.9fc	8'-2"
10'	6.3fc	10'-2"
12'	4.4fc	12'-2"

Zonal Lumen Summary

Zone	Lumens	% Luminaire
0-30	364	66.8
0-40	446	81.8
0-60	503	92.2
0-90	544	99.
90-180	1	0.2
0-180	545	100

Candela Table

Vertical Angles	Candela
0	635
5	621
15	525
25	354
35	124
45	38